

CO₂ - A REFRIGERANT FROM THE PAST WITH PROSPECTS OF BEING ONE OF THE MAIN REFRIGERANTS IN THE FUTURE

P. NEKSÅ, H. T. WALNUM and A. HAFNER

SINTEF Energy Research
Kolbjørn Hejes vei 1D, 7465 Trondheim, Norway
Petter.Neksa@sintef.no

ABSTRACT

Carbon dioxide was among the widely used refrigerants in the infancy of refrigeration around year 1900. Unlike ammonia, however, it more or less disappeared when the (Hydro)ChloroFluoroCarbons ((H)CFCs) were launched. After being re-introduced as a refrigerant around 1990, CO₂ has become an important alternative in replacing environmentally harmful refrigerants such as CFCs, HCFCs and HFCs. The development has shown potential in several applications both in terms of system efficiency and system cost, thus making it a viable alternative for applications not considered feasible earlier. This has been made possible through an enormous effort from industry, research institutes and universities. Currently, CO₂ is the refrigerant of preference for many companies, and commercial products are already available. For some applications there are still challenges to be overcome if introduction of CO₂ should become successful. The paper gives an overview of the far and near historic development of CO₂ as refrigerant and discusses future potential and challenges.

1. HISTORICAL DEVELOPMENT

Carbon dioxide was one of the first substances used as a refrigerant. Alexander Twining proposed its use as refrigerant in a British patent from 1850. It became the refrigerant of choice for several applications. Among these were marine refrigeration and air-conditioning. However, unlike ammonia, it did not survive the introduction of the CFCs and HCFCs. Registration of marine refrigeration systems from Lloyds register in London shows a gradual phase-out of CO₂ systems in use from 1950 until 1960.

Around 1990, when focus was put on the CFC and HCFC refrigerants' ozone depleting ability, and consequently, the Montreal Protocol was implemented to phase them out, CO₂ was introduced as one of the alternatives (Lorentzen, 1989). Figure 1 shows the CO₂ compressor from 1927 used in the initial investigations performed in 1988. In competition with the HFCs, CO₂ again managed to be a refrigerant of choice.

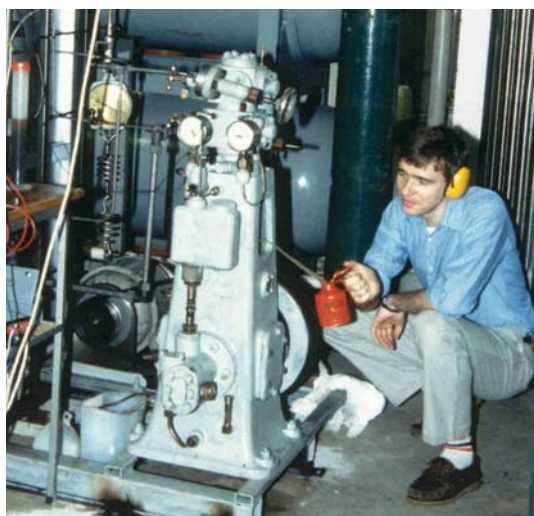

Fig 1. The CO₂ compressor from 1927 that was used during the initial investigations of transcritical cycle operation in 1988-89. Piston rod lubrication performed by H. Rekstad

In the first years after CO₂ was reintroduced, mainly two applications were in focus; mobile air conditioning, which accounted for almost 60% of the emissions from the refrigeration sector (Pettersen and Lorentzen, 1993), and heat pump water heaters, for which transcritical operation makes it possible to adapt very well to the gliding temperature heating demand required for tap water heating (Nekså, 1992 and Nekså *et al.*, 1998a). However, soon several other applications were approached with emphasis on investigating potential use of CO₂ as heat transfer fluid (HTF) (Rolfsmann, 1999), as refrigerant in a low temperature stage in a cascade (Gebhardt, 2002), or as the only refrigerant. The latter will most often require the possibility of transcritical operation under certain conditions, such as high ambient temperatures (Nekså *et al.*, 1998b).

Many of the applications investigated were met with considerable scepticism within the scientific community. High pressures levels, low theoretical cycle efficiency and need for development of new components and systems were common objections to the CO₂ technology. Partly the elements pointed out may introduce important challenges, but it has been shown that they may be overcome with proper adaptation of the systems to the applications investigated. The superior thermo-physical properties of CO₂ when used as refrigerant and the fact that it is non-flammable and non-toxic are often important factors. The higher operating pressures at given temperatures may in fact be an advantage since it leads to higher volumetric capacity, thus enabling more compact component and system designs.

From being obscure ideas of reintroducing CO₂ as working fluid in the 1980s, through investigating and developing prototype components and systems for several applications, there is now a considerable activity within industry, research organisations and universities. The number of publications in more dedicated conferences, such as the IIR Gustav Lorentzen Conferences, general conferences as the IIR Congresses and in journals and through patent applications, emphasises this.

Now, when the high GWP HFCs seems to be at the verge of being phased out as well, partly due to the focus put on greenhouse gas emissions by the Kyoto Agreement, CO₂ may become the preferred refrigerant in several new applications. Together with other natural refrigerants, most importantly hydrocarbons and ammonia, CO₂ should be able to cover most applications of refrigeration, air conditioning and heat pumps, and also being an alternative working fluid for Rankine cycles for power production from surplus heat.

The paper will through examples from different applications discuss future potential and challenges. An important challenge in many potential applications is to obtain competitive energy efficiency for operation when the heat sink temperature is high. This will most often mean heat rejection to high ambient temperature air. Different measures to overcome this challenge will be discussed and needs for research and development pointed out.

2. FUNDAMENTAL ASPECTS

Fundamental aspects of CO₂ used as refrigerant have been discussed in several publications, for instance Nekså (2002) and Kim *et al.* (2004). Compared to conventional refrigerants, the most remarkable property of CO₂ is the low critical temperature of 31.1°C. Vapour compression systems with CO₂ operating at normal ambient temperatures thus work close to and even above the critical pressure of 73.8 bar. The operation close to the critical point leads to three distinct features of CO₂ systems when used as the only refrigerant:

- **Heat is rejected at supercritical pressure when the heat sink temperature is high**

The system will then use a transcritical cycle that operates partly below and partly above the critical pressure. The high-side pressure in a transcritical system is determined by refrigerant charge and not by saturation pressure. The system design thus must consider the need for

controlling the high-side pressure to ensure a high COP and capacity. A refrigerant buffer volume is needed in order to enable charge variations, but since no liquid can be stored at the supercritical pressure, other options must be found. The most common is to buffer liquid on the low pressure side of the system or at intermediate pressure.

- **The pressure level in the systems will be relatively high, often between 30 and 120 bar**

The high operating pressure results in a high volumetric capacity. This is leading to smaller required cross sectional flow areas in the system and thus also smaller inner volume of the system. As a consequence, components should be redesigned to fit the properties of CO₂. The advantage is that components most often can be designed more compact since e.g. the compressor displacement needed for a given capacity compared with HFC-134a is 80-90% smaller. Further, compressor pressure ratios are low, thus giving favourable conditions for achieving high compressor efficiency. The relatively high operating pressures in evaporators and condensers/gascoolers also lead to very efficient heat transfer compared with HFCs, further enabling heat exchangers to be of a more compact design. Higher pressures are often associated with a higher hazard, but due to smaller volumes of piping and components, the stored explosion energy in a CO₂ system is not much different from that of a conventional system.

- **Large glide in temperature of the refrigerant during heat rejection**

At supercritical or near-critical pressure, all or most of the heat transfer from the refrigerant takes place by cooling dense single phase gas. The heat rejecting heat exchanger is therefore called a gascooler instead of a condenser. Since heat is transferred as sensible heat, the temperature will be gliding according to the actual high pressure. Gliding temperature can be an advantage in heat pumps for heating water or air. For other applications care must be taken in order to achieve as low refrigerant temperature as possible out of the gascooler. With proper heat exchanger design the refrigerant can be cooled to less than or a few degrees above the entering coolant (air, water) temperature, and this improves the COP of the systems compared to if typical temperature approach assumptions from simple cycle comparison approaches are used. It should be noted that provided the gas cooler outlet temperature can be cooled to a sufficiently low temperature, the COP will be higher than in a typical HFC system. Internal heat exchange to subcool high pressure gas with the compressor suction gas may also improve efficiency, especially at high ambient temperatures.

When CO₂ is used as a low temperature fluid in cascade systems, for example in combination with ammonia, pressure levels in the CO₂ stage can be kept to a more conventional level, for example below 25 or 40 bar. Then components and tubing commonly used for other refrigerants can be used, often without adjustment. CO₂ is also commonly used as a heat transfer fluid (HTF) in combination with other refrigerants. This results in considerably lower pumping power requirement than for brine systems, especially at low temperatures.

Due to the difference in CO₂ thermophysical properties and cycle characteristics compared to HFC refrigerants, typical system efficiency curves (e.g. cooling COP) shows different trends with the heat sink temperature, see Figure 2. CO₂ tends to be more efficient at lower ambient temperatures, while HFC systems may be slightly more efficient at the highest ambient temperatures. When comparing energy efficiency for CO₂ systems and alternative technologies, it is therefore essential to make a seasonal comparison based on the operating conditions the systems will experience during the year. A comparison only at typical rating conditions, e.g. 32 or 40°C, will not give a fair comparison with respect to energy consumption over the year. Usually the rating point is given for the most severe condition the equipment is likely to experience. The system only will experience temperatures around the design point for shorter periods of the year, see Figure 3 (red vertical line represents 35°C). It is important to ensure that the required cooling or heating capacity is achieved at these conditions. However, this is merely a matter of design.

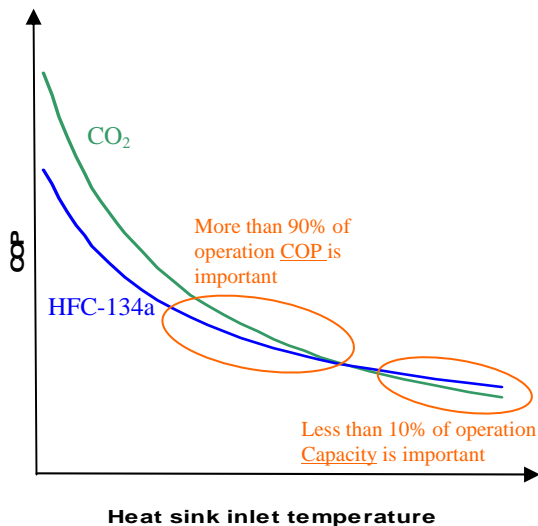

Fig 2 Typical COP vs condenser/gascooler inlet temperature of heat sink

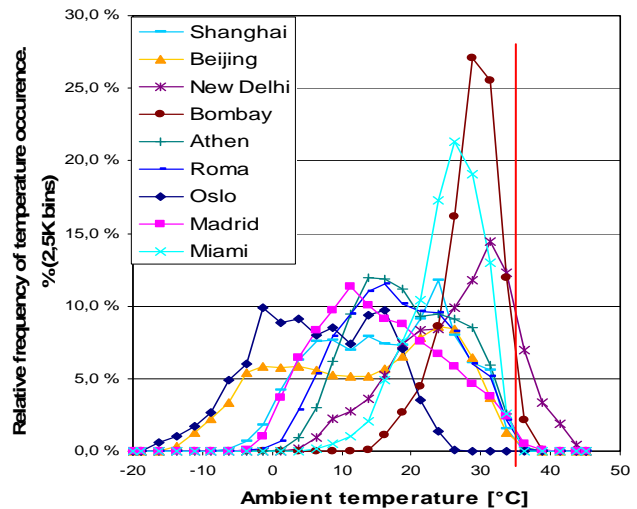

Fig 3 Temperature bin curves for a variety of hot and moderate temperate cities world-wide

Operation at the rating point condition will usually not be important for the annual energy consumption of the equipment. Life cycle climate performance evaluations (LCCP), is one way to address comparison to other alternatives, taking into account indirect emissions due to power consumed of the system at varying operating conditions during a year, direct emissions related to refrigerant emissions, and emissions related to system production and demolition/scraping.

For some applications, however, efficiency at high heat sink temperatures needs to be addressed more carefully. This may be due to limitations in power supply or due to continuous or long-term operation at these conditions. Cycle improvements of different kinds may then be required, such as alternative cycle modifications, e.g. parallel compression, or including work recovery during expansion. Different options will be discussed in connection with various applications in the following section.

3. APPLICATIONS AND THEIR CHALLENGES

Technology for CO₂ as refrigerant has been developed for a range of applications. Concentrating on systems with CO₂ as the only refrigerant one may range the readiness of technology in the order:

- Already developed and commercialised
 - Heat pump water heaters – domestic, commercial and industrial sized
 - Commercial refrigeration systems, supermarkets
 - Beverage coolers
 - Ice cream chest freezers
 - Water chillers for moderate climates, air conditioning and industrial
 - Transport refrigeration (bus, train)
- Already developed – not yet commercialized
 - Mobile air conditioning systems
- Under development
 - Mobile heat pumps
 - Transport refrigeration systems (containers, truck, marine)
 - Residential heat pumps (space heating and reversible)
 - Vending machines for combined hot and cold beverages
 - Combined heating and cooling of non-residential and residential buildings
 - Heat pumps for space heating and combined space and water heating

- Heat pump dryers of residential and commercial size, e.g. laundry applications
- Rankine power cycles for utilisation of low temperature surplus heat

- Early development
 - Residential air-conditioning systems
 - Water chillers for hot climates, air conditioning and industrial
 - Industrial refrigeration and heat pumps

The list is not meant to give a complete picture, but illustrates that CO₂ technology already now has become an important alternative. Component availability in different capacity ranges have been developed, even though production numbers for some of them still is an issue in order to obtain competitive cost with HFC components. Another important barrier for some applications is energy efficiency at high heat sink temperatures. The most important barrier may however be the scepticism to new technology among both manufacturers and end-users. In the following subsections status and challenges for some important applications are discussed.

3.1 Heat pump water heaters

Heat pump water heaters, used for heating tap water typically from 10°C to 65°C, is an application very well suited for the transcritical CO₂ cycle (Nekså, 1998a). After the initial development phase in the period 1990-98, successful commercialisation was made in Japan from 2001 with help of governmental incentives aiming to move water heating from fossil fuel heating to heat pumps. About 1.7 million units were installed between 2001 and 2008. The aim is to install 5.2 million units within 2010, which would reduce CO₂ emissions in Japan with about 2.9 Mt-CO₂/year, corresponding to about 5% of Norway's CO₂ emissions. A significant improvement of the systems has taken place since market introduction in 2001, to make the efficiency even higher (Hashimoto, 2006). The improvements have been done both on components, such as compressors and heat exchangers, as well as introducing ejectors for energy recovery. Currently, seasonal performance factors are above 4. Systems both for residential, commercial and industrial use are now also introduced in Europe by several manufacturers. With the increasing importance of tap water heating due to less heating demand in low energy buildings, this technology should have great prospects.

3.2 Mobile air conditioning and heat pumps

Mobile air conditioning was among the first applications addressed when CO₂ was reintroduced. Systems using CO₂ as refrigerant have readily been developed by several OEMs. Equal or superior performance compared to HFC-134a systems has been demonstrated, even for small cars operating in hot climates (Hafner and Nekså, 2007). The constrained nature of the application both regarding system weight and volume makes it possible to utilise the good thermophysical properties of CO₂ to make compact and light-weight systems with high energy efficiency.

The phase-out of HFC-134a in EU in this application for all new car models from 2011 will require a shift of refrigerant. CO₂ and HFC-1234yf seems to be the most realistic alternatives. The hydrofluorocarbon HFC-1234yf has a low GWP, but is a new and unknown chemical. Unavoidable emissions will cause known and potentially unknown negative impacts to the local and global environment due to the decomposition products formed, see e.g. Kajihara *et al.* (2010). Technically, CO₂ technology is already developed; it is now more a policy decision to decide on a technological shift to CO₂ or to choose a third generation halocarbon with unknown future consequences. What also makes it complicated is that a common world-wide refrigerant choice would be preferable.

CO₂ is also a very good alternative refrigerant for future vehicle heat pumps. This will be an important application for fuel efficient cars with less excess heat available and hybrid or electrical cars with little or no waste heat available for heating during the cold season, especially for moderate and colder climates. CO₂ systems perform very well for such heat pumps as demonstrated e.g. by Mager *et al.* (2002).

3.3 Commercial refrigeration

Commercial refrigeration systems for supermarkets was an application for which parts of the scientific community saw small chances for all-CO₂ systems, or even use of CO₂ at all. As late as year 2000, an Informatory Note was issued, only mentioning potential use of CO₂ in cascade or as a heat transfer fluid (HTF) (IIR, 2000). Now, several system manufacturers and supermarket chains have decided to make all-CO₂ systems their preferred choice for future installations.

CO₂ is an important refrigerant alternative to HCFCs and HFCs in commercial refrigeration systems since it is the application area within the refrigeration sector with the largest refrigerant greenhouse gas (GHG) emissions. Developments for using CO₂ as HTF, in cascade systems or for all-CO₂ systems took place in parallel, starting in the 1990s. It was also used for retrofitting in Sweden, where several supermarkets around 1995 were converted from HCFC-22 by using CO₂ as HTF in the old display cabinets (Rolfsmann, 1999).

Some of the major commercial refrigeration manufacturers and contractors have introduced direct expansion systems using CO₂ as the only refrigerant with a transcritical/subcritical cycle depending on ambient temperature, supplying both low- and medium-temperature refrigeration. More than 200 supermarkets have been built in Europe with this kind of system design, from Italy in the south to Norway in the north, with a cooling capacity range of 50 to 1200 kW. Energy consumption and cost are reported to be within the range of today's direct expansion (DX) R-404A systems and indirect system designs. A recent review article by Tassou *et al.* (2010) also points to CO₂ based systems, as the only refrigerant or in cascade, as a probable dominant technology in the future.

Berg (2009) reports initial cost on parity for larger systems, while systems for smaller supermarkets tend to be 10-20% more expensive. Comparison of energy consumption for six different supermarkets in Norway (about 1500m² each) with heat recovery (three with R-404A systems and three with CO₂ systems) showed all lower energy consumption for the CO₂ based systems. A life-time assessment was therefore always lower in cost for the CO₂ option.

In moderate climates, the possibility to do heat recovery will always be important. Due to the refrigeration load from the display cabinets in the supermarket, the period for heat demand is considerable. CO₂ systems have important advantages since it is possible to supply large parts of the heat required very efficiently. It will also be possible to make direct heat exchange between CO₂ and the air heating system, enabling a cost efficient concept.

High ambient temperature operation is the most challenging. Giroto *et al.* (2004) and Giroto (2007) showed that low temperature refrigeration systems compete well with R-404A DX, but at medium temperature, the CO₂ system suffered in efficiency. Based on the experimentally funded assumptions in these references, COP curves for R-404A and CO₂ are shown as full lines in Figure 4. At 30°C ambient temperature, the COP is about 10% lower for the CO₂ system. Different options exist for improving this situation. The two upper curves represent the options of utilising parallel compression from an intermediate pressure receiver (orange dotted curve with triangles) and utilising an expander to intermediate pressure which operates a parallel compression stage (dotted black line with cross). Isentropic efficiency of the compressor and expander is assumed 60%.

An interesting observation is that the introduction of an expander does not increase the COP compared to parallel compression, even though it opens for compression of some of the flash gas without work input. This has two main reasons. The cycle is restricted to a relatively high intermediate pressure, since all the flash gas needs to be recompressed by the work extracted by the expander. The second reason is that the optimum high pressure for the cycle is relatively high, since the expander needs a quite large pressure difference to extract work.

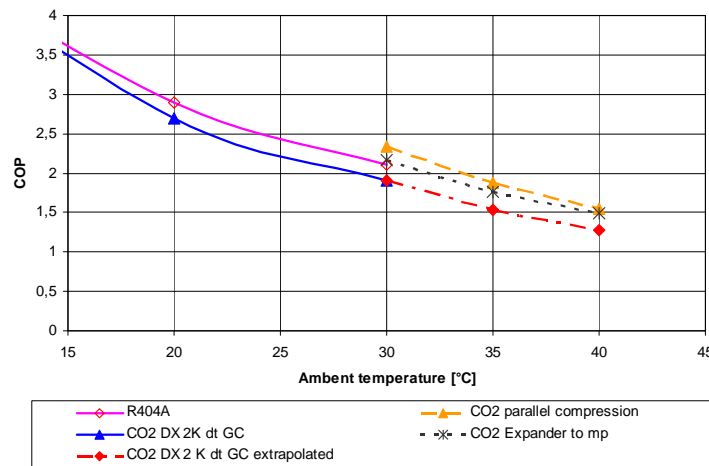

Fig. 4 Comparison of system COP for medium temperature refrigeration. Full lines represent simulations based on measured data. Dotted lines represent simulations made for an extended temperature range and for different improvement possibilities.

The difference between the *expander cycle* and the *parallel compression cycle* decreases with increasing ambient temperature. This is because the optimum intermediate and high pressure level for the parallel compression cycle increases with increasing ambient temperature, and approaches the optimum pressures for the expander cycle.

The results show that the efficiency gap observed at higher ambient temperatures for a medium temperature application may be closed. Parallel compression is possible to implement already with existing components. Another possibility is to utilise evaporative cooling at heat rejection. This would of course benefit both CO₂ and R-404A, but the relative gain would be higher for CO₂. Further results on these options and other cycle options are reported in Girotto and Minetto (2008).

Also in the light commercial sector, including stand-alone equipment such as bottle coolers and vending machines, some of the major companies have introduced CO₂ technology. Several thousands of units have been installed in pre-commercial deployment tests, with an expected number of 85,000 by the end of 2009 (Azar, 2009). In the application of hot and cold vending machines, being important especially in Japan, CO₂ also give important advantages when both the hot and cold side of the cycle can be utilised (Jakobsen, 2006 and Tsuchiya, 2006).

3.4 Residential air conditioning and heating

Reversible air-to-air heat pumps with CO₂ as refrigerant have been investigated by industry and research institutions. Since this is the application with the highest production numbers, alternatives to HFCs in this application would be of great interest. Jacobsen *et al.* (2006 and 2007) made experimental and theoretical evaluation of a prototype CO₂ reversible split type system at conditions representative for Athens and Oslo and comparing it with highly efficient HFC 410A systems on the market. The CO₂ system competed very well in heat pump mode for both hot and moderate climates. The seasonal cooling performance was competitive in air conditioning mode, but COP at the highest ambient temperatures, above 30°C, were poorer. Figure 5 displays the results found by Jacobsen *et al.* (2006), extrapolated to an ambient temperature of 45°C by simulations, and with different improvement possibilities implemented. The CO₂ system with assumed improved compressor efficiency to 65% (actual 54%) and intercooling is represented by the upper full light green curve. It outperforms the HFC-410A reference units at ambient temperatures below 30°C. At the highest ambient temperature with test results, 36°C, the CO₂ system is 29% and 5% lower in COP respectively compared to reference unit 1 and 2.

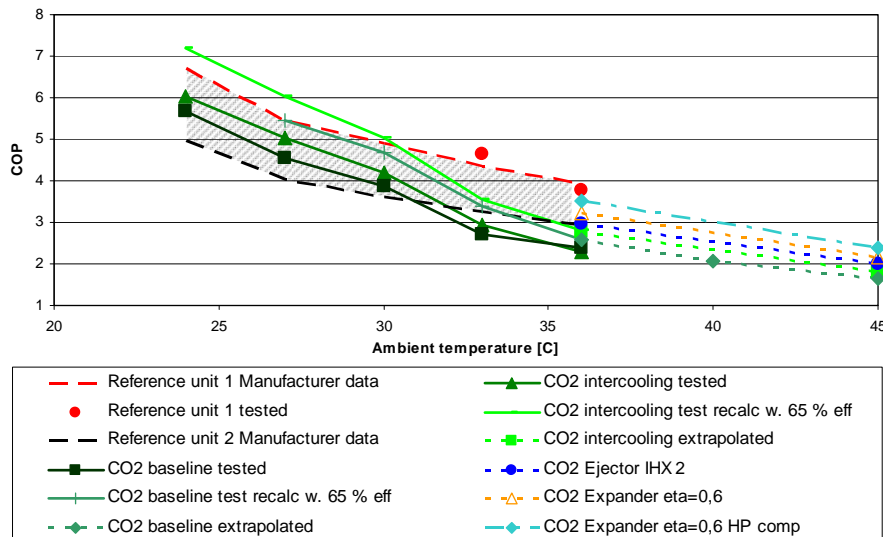

Fig. 5 Comparison of system COP in Athens climate for a CO₂ prototype system with two HFC-410 reference units at varying ambient temperatures. Simulations based on the experimental data to higher ambient temperatures and by implementing cycle improvements are presented

The upper dashed turquoise line represents the CO₂ system if a second stage compression is driven by an expander with assumed efficiency 60% and the dashed blue line a system with an ejector with an efficiency based on experimental experience. At 36°C ambient the COP of the CO₂ system is increased with 26% and 7% respectively, corresponding to COP values 6% and 21% lower than the best reference unit tested, but higher than the reference unit 2. This shows that it should be possible to reach the same efficiency level as high efficiency HFC-410A units even at the highest ambient temperatures. However, component and cycle improvements are required, and perhaps equally challenging, within an acceptable cost level.

3.5 Transport refrigeration

CO₂ HVAC systems are viable alternatives to HFC-systems in the public and goods transport sector. Sonnekalb *et al.* (2009) show an innovative roof concept for bus air conditioning with flexible and time saving mounting in order to reduce life cycle costs. The CO₂ prototype has proved its high efficiency for more than 6,000 operating hours since 1996. In addition to the unit for AC operations, an air-to-air heat pump for a concept-bus was presented. Rindsfusser (2008) shows similar concepts for both city buses and coaches.

Hafner and Christensen (2010) describe the opportunity for use of CO₂ as refrigerant in air conditioning systems for public trains. Today, 75% of the air conditioning systems in trains use HFC-134a as refrigerant. The CO₂ system shall provide cooling in the summer and heating in the winter. Radial piston compressors, which are extremely compact solutions for applying CO₂, have been trialed in the first trains and are certified for use on railways.

Container and transport refrigeration is a demanding application field; however, CO₂ is a sustainable alternative to HFC refrigerants in this area, where compactness and reliability is extremely important.

3.6 Industrial refrigeration, air conditioning and heat pumps

CO₂ has become an important refrigerant within industrial refrigeration for use in a low temperature stage of cascade systems, with ammonia in the upper stage. For low temperature refrigeration this combination can both increase efficiency and also reduce the investment cost. It is also an important option in order to reduce ammonia charges, where this may be an issue. Cold storage and ice rink systems are example applications.

Transcritical CO₂ systems have also been proposed by Visser (2007) for applications where there is a combined high demand for hot water and cooling, e.g. in meat processing plants, and for office air conditioning primarily. Concepts for district heating systems have also been proposed by several. These are large capacity systems. Heat pump systems with capacity up to 4 MW are now offered in the market utilising screw compressors.

4. COMPONENTS

There has been a tremendous development of components for CO₂ during the latest years. To give a full overview this is therefore not possible in the limited space available. Rather some elements are focused in more detail, and others more on a comment basis, with focus to components enabling transcritical CO₂ systems.

4.1 Ejector

Replacing the throttling valve by an ejector to recover some kinetic energy from the expansion process is not a new concept. The ejector cycle was invented by Gay (1931). Kornhauser (1990) showed a theoretical improvement of up to 21% in the COP by using an ejector instead of a throttling valve in a CFC-12 refrigeration cycle. However, only 3.8% COP improvement was measured by Menegay and Kornhauser (1996).

Applying an ejector in a CO₂ transcritical system has the potential of larger COP improvements due to the higher relative throttling loss. The main advantages of using an ejector in a CO₂ system are:

- Reduction of the evaporator inlet vapour fraction, which improve the heat transfer in the evaporator and the refrigerant distribution in parallel flow heat exchangers;
- Reduction of compressor work, due an increase in suction pressure of the compressor and thereby reducing the compression ratio, and increased refrigeration efficiency by recovering parts of the expansion losses.
- Possibility to perform evaporation at two different temperature levels, in principle replacing one compressor stage

Transcritical CO₂ ejector cycles have been analysed theoretically and experimentally for some years. The test result by Ozaki *et al.* (2004) illustrates that using an ejector in car air-conditioning can give approximately 20% COP improvement. Simulation and experimental results by Elbel and Hrnjak (2004, 2006) reveals that the use of an ejector in CO₂ transcritical systems yields approximately 10% higher COP and 8% improvement in cooling capacity. Results from both authors are reported for high ambient conditions.

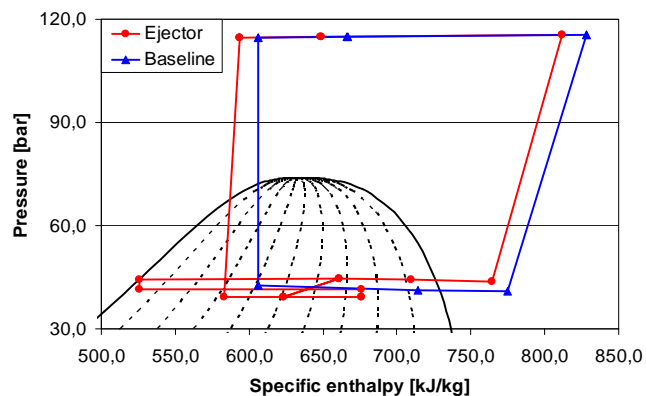
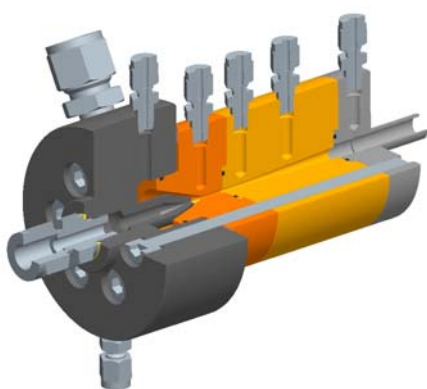

Fig. 6 a) Prototype ejector from SINTEF designed for detailed investigation of ejector elements. b) Ejector cycle (red) versus ordinary CO₂ cycle (blue) with heat rejection at 45°C ambient temperature

Still development related to efficiency of the different ejector elements and methods for implementation in systems at varying operating conditions is needed. Figure 6a shows a newly developed prototype for detailed investigation of ejector elements. Figure 6b illustrates in a p-h diagram operation at 45°C ambient temperature and equal capacity for a cycle with an ejector implemented (red) and an ordinary CO₂ cycle (blue).

Applying an ejector in a transcritical CO₂ system is a promising method to increase the system efficiency at high ambient conditions. Its simplicity in construction, no moving parts comparing to e.g. expanders, low cost and reasonable efficiency, make it closer to practical implementation than many other alternatives for cycle improvement, and are implemented in heat pumps on the market.

4.2 Expander

Several expander concepts for CO₂ have been investigated and developed, e.g. piston, rotary vane, scroll and turbo, but so far none of them seem to have been commercialised. This is an important future task since cost efficient concepts could improve system efficiency in general for many applications, but maybe more important enable commercialisation within applications which today are not able to compete in efficiency at certain conditions, e.g. high heat-sink applications. In many applications the use of CO₂ as refrigerant introduces relatively high expansion losses. The potential work recovery will, therefore, often be larger than for other refrigerants.

4.3 Heat exchangers

Highly efficient heat exchangers can be realized due to the unique properties of CO₂ as working fluid. Very favourable heat transfer coefficients may be achieved at the same time as the high volumetric capacity enables very small cross sectional flow areas. However, challenges do exist. Phenomena such as dry out at high evaporation temperatures and high vapour qualities, maldistribution in manifolds and lubricant effects, still needs to be handle. Having investigated and understood these phenomena and the basic properties of CO₂, has enabled development of a variety of efficient and compact heat exchanger types, e.g. tube-in-fin, multi-port extruded tube, plate-in-shell, shell-and-tube and plate heat exchangers.

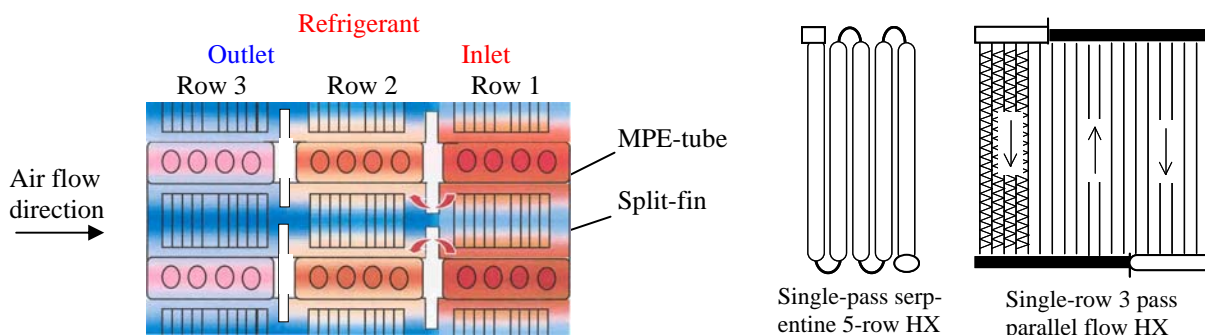

Figure 7 Temperature profile (tube wall temperature, qualitative) in a segment of a 3-row heat exchanger with split fins (left) and two different types of MPE compact heat exchangers (right) (Hafner, 2003)

Due to the relatively high temperature glide of CO₂ during supercritical heat rejection, special attention must be paid to design of compact gascoolers to avoid heat conduction in fins between hot and cold parts of the heat exchanger. Heat conduction may reduce efficiency of the system considerably. In compact heat exchangers, split fins should be applied to minimise exergy losses of the process, see Figure 7 (left). Two MPE heat exchangers concepts are illustrated on the right.

4.4 Compressor

The thermophysical properties of CO₂ in some aspects give very good possibilities for efficient compression. Typically, compression ratios are low, the temperature drop for a given pressure drop is low and required swept volumes and flow areas are small. On the other hand, pressure

differences, temperature differences and bearing loads encountered may be very high, giving challenges especially for some types of compressors.

Just after CO₂ was reintroduced, mainly piston type compressors were focused. There was also raised doubt about the possibility to develop for instance scroll compressors for high pressure CO₂ compression. Now, more or less all types of compressors have been developed and commercialised, and the capacity range covers smaller capacity applications, like bottle coolers, to high capacity heat pumps. The variety of types is biggest in the small capacity range, while piston compressors dominate in the medium to large capacity. The introduction of screw compressors enables to cover the high capacity range, while custom made turbo compressors can cover the highest capacities. Some mid-sized compressors available are illustrated in Figure 8.



Figure 8 Some commercially available compressors in the mid-capacity range

Still there are capacity gaps in the range of compressors available, and for many of the compressors further improvement in efficiency would be preferable. A future task could be to develop efficient oil-free compressor concepts. This would enable full utilisation of the favourable heat transfer capabilities of pure CO₂ and would also enable simplification of the system layout.

5. CONCLUSION

A tremendous development of CO₂ technology has taken place since the revival of the refrigerant around 1990. The development has led to efficient CO₂ systems that have been introduced in the market, but also inspired developments for other technologies. Ongoing development in several applications and in development of components and novel system designs are expected to enable commercialisation in several applications in the near future. Challenges exist in achieving energy efficiency and competitive system cost in some application areas. However, looking at the results achieved in the development so far and the considerable research and development effort ongoing, it is expected that the challenges may be overcome for many new applications. The focus on reducing GHG emissions and environmental aspects as such is also expected to further encourage increased use of natural refrigerants in general and CO₂ in particular.

6. ACKNOWLEDGMENTS

This publication is written with support from the research project CREATIV, financially supported by the Research Council of Norway (p.no.195182/S60) and several industry partners; Danfoss, FHL, Hydro Aluminium, John Bean Technology, Norske Skog, REMA1000, Systemair, TINE.

REFERENCES

- 1 Azar, A. (2009): Sustainable Refrigeration for Commercial Applications, *Pres. at Atmosphere 2009*, Brussels, October 19-20
- 2 Berg, F. (2009): Results from comparison of six supermarkets in Norway, *Personal communication with F. Berg*, Kuldeteknisk AS, Tromsø, Norway
- 3 Elbel, S.W. and Hrnjak P.S. (2004): Effect of internal heat exchanger on performance of transcritical CO₂ systems with ejector, *International Refrigeration and Air Conditioning Conference at Purdue*, U.S.A.
- 4 Elbel, S.W. and Hrnjak, P.S. (2006): Experimental validation and design study of transcritical CO₂ prototype

- 5 Gay, N. H. (1931): Refrigerating system. *U.S. Patent No.1,836318*
- 6 Gebhardt, H (2002): Adaptation of an industrial low temperature refrigerating plant from R 22 to CO₂/NH₃ (in german), *Die Kälte und Klimatechnik*, vol. 55, no10, pp. 102-112
- 7 Girotto, S., Minetto, S. and Neksa, P. (2004): Commercial refrigeration system using CO₂ as the refrigerant, *Int. J. of Refrigeration* 27 (2004), pp. 717-723
- 8 Girotto, S. (2007): Carbon Dioxide in Supermarket Refrigeration, *Pres. at Co2ol Food – climate friendly refrigeration in supermarkets*, Berlin, May 23
- 9 Girotto, S. and Minetto, S. (2008): Refrigeration Systems for Warm Climates Using Only CO₂ as a Working Fluid, *Natural refrigerants. Sust. Ozone and Climate Friendly Alt. to HCFCs*, GTZ Proklima Int., pp. 287-301
- 10 Hafner, A. (2003): Compact Interior Heat Exchangers for CO₂ Mobile Heat Pumping System, *Dr.ing thesis 2003:69at NTNU, Dep of Energy and Process Engineering*, Trondheim
- 11 Hafner, A. and Neksa, P. (2006): Global environmental consequences of introducing R-744 (CO₂) mobile air conditioning, *7th IIR Gustav Lorentzen Conf. on Natural Working Fluids*, Trondheim, May 28-31
- 12 Hafner, A. and Christensen, Ø. (2010): Reversible R744 (CO₂) Heat Pumps Applied in Public Trains, *9th IIR Gustav Lorentzen Conference on Natural Working Fluids*, Sydney, Australia, April 10-14
- 13 Hashimoto, K. (2006): Technology and market development of CO₂ Heat Pump Water Heaters (Ecocute) in Japan, *IEA Heat Pump Centre Newsletter*, Vol 24 No 3, pp 12-16
- 14 IIR (2000): Carbon Dioxide as refrigerant, 15th Informatory note on refrigerants, *Int. Institute of Refrigeration*, Paris
- 15 Jakobsen, A., Skiple, T., Skaugen, G. Azar, A. and Neksa, P. (2006): Development of CO₂ Vending Machine for Simultaneous Heating and Cooling, *7th IIR Gustav Lorentzen Conference on Natural Working Fluids*, Trondheim, Norway, May 28-31
- 16 Kajihara, H., Inoue, K. Yoshida, K. and Nagaosa, R. (2010): Estimation of environmental concentrations and deposition fluxes of R-1234-YF and its decomposition products emitted from air conditioning equipment to atmosphere, *2010 Int. Symp. on Next-generation AC and Refrigeration Techn.*, 17-19 Febr., Tokyo, Japan
- 17 Kim, M.H., Pettersen, J., Bullard, C.W. (2004): Fundamental process and system design issues in CO₂ vapor compression systems, *Progress in Energy and Combustion Science*, Volume 30, Issue 2, pp 119-174, ISSN 0360-1285
- 18 Kornhauser, A.A. (1990): The use of an ejector as refrigerant expander, *Proceeding of the 1990 USNC/IIR-Purdue refrigeration Conference*, Purdue University
- 19 Lorentzen, G. (1989): Method of operating a vapour compression cycle under trans- or supercritical conditions, *European patent 0424474B2*, Priority date 09.01.1989
- 20 Lorentzen, G. (1993): Revival of carbon dioxide as a refrigerant. *Int J Refrig* 17 5, pp. 292–301
- 21 Mager, R., Hammer, H. and Wertenbach, J. (2002): Comparative study on AC- and HP-systems using the refrigerants R134a and R744, *VDA Alternate Refrigerant Wintermeeting*, Saalfelden, 2002 (<http://www.vda-wintermeeting.de>)
- 22 Menegay, P. and Kornhauser, A.A. (1996): Improvements to the ejector expansion refrigeration cycle, *Proceeding of 31st Intersociety energy conversion engineering conference*, Washington, D.C.
- 23 Neksa, P. (1992): The transcritical vapour compression cycle. Its potential in heat pump processes, *Proceedings of "Refrigeration, Energy and Environment" Int. Symposium on the 40th Anniversary of NTH Refrigeration Engineering*, June 22-24, 1992, Trondheim, Norway
- 24 Neksa, P., Rekstad, H., Zakeri, G.R. and Schiefloe, P.A.(1998a): CO₂ – heat pump water heater: characteristics, system design and experimental results, *Int. J. Refrig.* Vol. 21, No. 3, pp. 172-179
- 25 Neksa, P., Girotto, S. and Schiefloe, P.A. (1998b): Commercial Refrigeration Using CO₂ as Refrigerant – System Design and Experimental Results, *IIR Conference: Natural Working Fluids '98, IIR - Gustav Lorentzen Conference*, Oslo, June 2-5
- 26 Neksa, P. (2002): *CO₂ Heat Pumps*, *Int. J of Refrigeration*, Vol 25, Issue 4, June 2002, p 421-427
- 27 Ozaki, Y., Takeuchi, H. and Hirata, T. (2004): Regeneration of expansion energy by ejector in CO₂ cycle. *Proceedings of the 6th IIR-Gustav Lorentzen Conference on Natural Working Fluids*, Scotland, U.K.
- 28 Pettersen, J. and Lorentzen, G. (1993): *A new, efficient and environmentally benign system for automobile air conditioning*, Proc. of Vehicle Thermal Management Systems Conference, Columbus, March 1993
- 29 Rindsfusser, M. (2008): R-744 AC Systems – Challenges for Coach and City Bus Applications, *VDA Alternate Refrigerant Wintermeeting*, Saalfelden, 2008 (<http://www.vda-wintermeeting.de>)
- 30 Rolfsmann, L. (1999): Plant design considerations for cascade systems using CO₂, *20th International Congress of Refrigeration, IIR/IIF*, Sydney
- 31 Sonnekalb, M, Försterling, S and Tegelthoff, W. (2009): CO₂ Air Conditioning and Heating applied to city buses, *VDA Alternate Refrigerant Wintermeeting*, Saalfelden, 2009
- 32 Tassou, S.A., Lewis, J.S., Ge, Y.T., Hasaway, A. and Chaer, I. (2010): A review of emerging technologies for food refrigeration applications, *Applied Thermal Eng.*, 30 (2010) pp 263-276
- 33 Tsuchiya, T. and Takiguchi, K. (2006): Development of automatic drink vending machines with CO₂ refrigerant, *IEA Heat Pump Centre Newsletter*, Vol 24 No 3, pp 17-20
- 34 Visser, K. (2007): The environmental benefits of using the natural refrigerant carbon dioxide as a cooling source in office air conditioning and industrial refrigeration, *Pres. c-dig meeting August 27-29*, Tokyo